

Storm Banner Stand

UB201

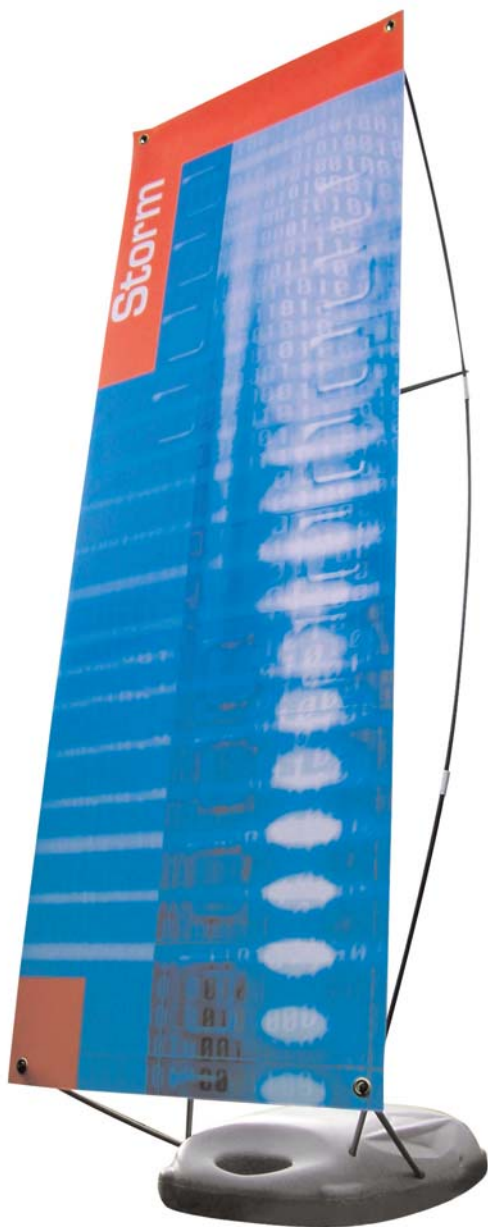

This purpose built banner stand is built for durability and strength and is ideal for outdoor promotions. The oversized hollow base can be filled with either water or sand, making it especially suitable for high traffic areas or extreme weather conditions.

features & benefits

- Single or double sided (UB201A) outdoor banner in grey
- Ideal for point of sale, retail display or exhibition environments
- Hollow plastic base for water or sand weighting agent
- Supported on simple eyelet system
- Weather resistant
- Includes canvas carry bag



double sided banner

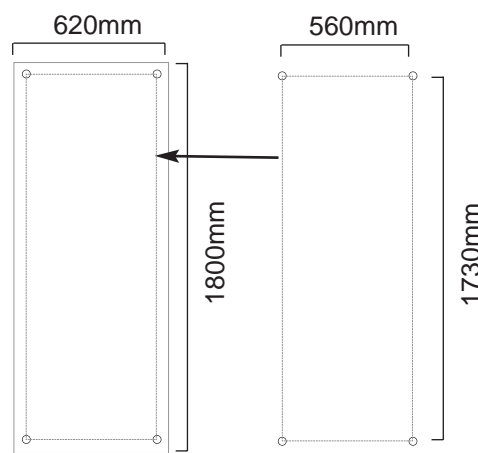

graphic dimensions

eyelet positioning
1730mm (h) x 560mm (w)
measuring to centrepoints
of eyelets

hardware specifications	graphic specifications	additional info
<p>Hardware Dimensions (mm) 2000 (h) x 620 (w) x 830 (d)</p> <p>Weight: 5.5kg approx when empty and 17kg approx when filled with water (approx 12 litres in total)</p>	<p>Visible Graphic Dimensions (mm): 1800 (h) x 620 (w)</p> <p>Substrate: Woven PVC banner material. Recommend 13mm eyelets</p>	<p>Included in kit: Base, connection rods, support rods, bracing bar, canvas carry bag</p> <p>Availability: Grey</p>

Assembly Instructions



Kit includes: 4 in-line connection rods, 4 banner support rods, base, bracing bar and carry bag



1 Fill the base with either water or sand (ensure the top is tightened securely)

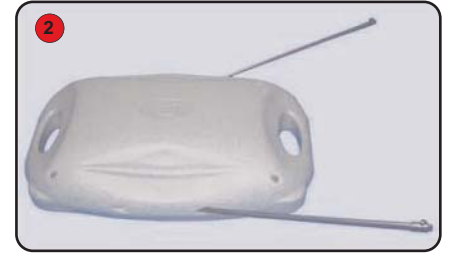

2 Push fit both shorter banner support rods into either side of the base.

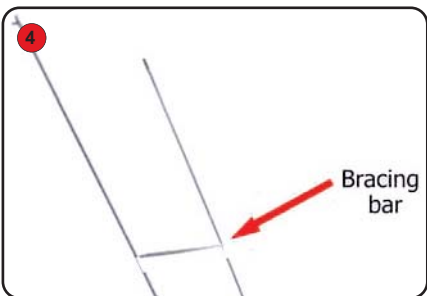
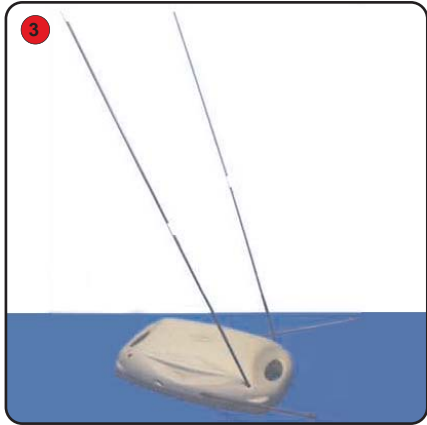

3 Construct the in-line connection rods and fit into the top of the base.

4 Fit the bracing bar, sandwiching it between the in-line connection rods and the longer banner support rods to complete the frame.

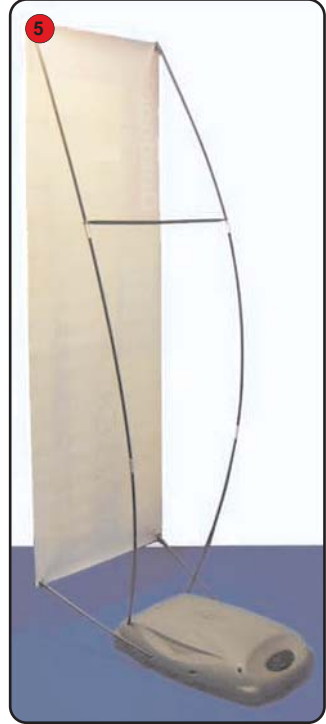

5 Fit the shorter banner support rods through the eyelets at the base of the banner. Push the frame forward to bring it into tension.

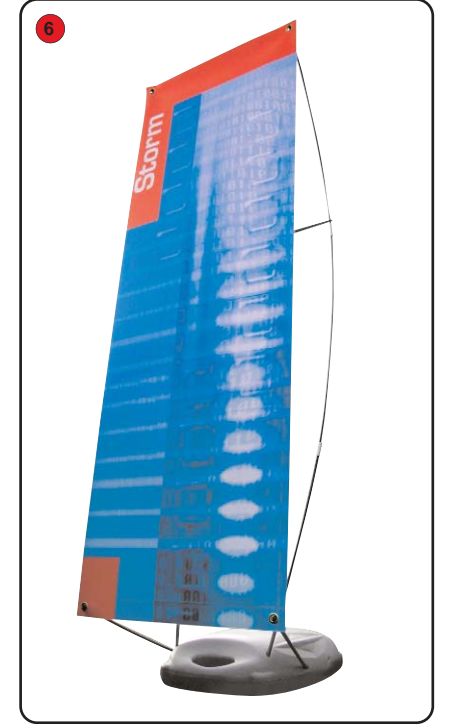

6 Finally fit the longer support rods through the eyelets at the top of the banner to complete. (Repeat from step 3 for double sided banners).

Other products in our outdoor retail range include:



Storm Pro

Single sided banner with telescopic aluminium support pole, hollow plastic base for water or sand weighting for total stability.



Horizon

Indoor or outdoor double sided banner with telescopic variable height up to 2500mm and extends to 3000mm wide but units can link together to form seamless wall.



Wind Dancer Maxi

Telescopic flag pole, adjustable height up to 5300mm. Hollow base for water or sand weighting for total stability.